



Sistemas de depósitos



¡Obtén monedas con cada vaso!

SATA® LoyaltyProgram
coins & more

Más información en: www.sata.com/loyalty

Sistema de vasos multiusos SATA® RPS



SATA RPS

¡Apropiado para todos los materiales de pintura! Para escoger el tamiz idóneo (tamiz plano 125 µm o tamiz de enchufe 200 µm). Por favor, debe tener en cuenta la recomendación del fabricante de pintura.



SATA RPS 0,3 l minijet para SATA minijet 3000 B

Caja de 60 uds.

1010553	SATA RPS 0,3 l minijet, 125 µm tamiz plano		
1010561	SATA RPS 0,3 l minijet, 200 µm tamiz de enchufe		

SATA RPS 0,3 l estándar

Caja de 40 uds. Caja de 100 uds.

1010389	1010420	SATA RPS 0,3 l estándar, 125 µm tamiz plano	Caja de 40 uds.: Caja de 100 uds.:	
1010397	1010404	SATA RPS 0,3 l estándar, 200 µm tamiz de enchufe	Caja de 40 uds.: Caja de 100 uds.:	

SATA RPS 0,6 l

Caja de 60 uds.

1010438	SATA RPS 0,6 l 125 µm tamiz plano		
1010488	SATA RPS 0,6 l 200 µm tamiz de enchufe		

SATA RPS 0,9 l

Caja de 40 uds.

1011973	SATA RPS 0,9 l, 125 µm tamiz plano		
1011981	SATA RPS 0,9 l, 200 µm tamiz de enchufe		

SATA RPS 0,6 l UV

Caja de 60 uds.

1010496	SATA RPS UV 0,6 l 125 µm tamiz plano		
1010503	SATA RPS UV 0,6 l 200 µm tamiz de enchufe		

Todos los precios son precios de venta recomendados no obligatorios. Errores, modificaciones técnicas y erratas reservados.

Recambios SATA® RPS®

Ref./Descrip.
1013226 tapas de reemplazo para SATA RPS 0,6 l / 0,9 l (caja de 80 unidades)
131979 Tamiz plano de reemplazo de 125µm, azul pastel (paquete de 100 unidades) para SATA RPS 0,6l / 0,9l
131987 Tamiz de enchufe de reemplazo de 200µm, verde pastel (paquete de 100 unidades) para SATA RPS 0,3 / 0,6l / 0,9l
160606 Tamiz plano de reemplazo de 125µm, azul pastel (paquete de 60 unidades) para SATA RPS 0,3l
1013218 Tapas de reemplazo para SATA RPS 0,3 l estándar (caja de 60 unidades)
1013234 Tapas de reemplazo para SATA RPS 0,3 l minijet (caja de 108 unidades)

SATA RPS 0,3 l estándar

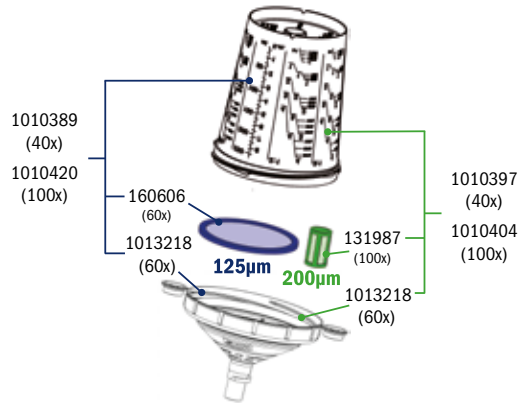

SATA RPS 0,3 l minijet (para SATAMinijet 3000 B)

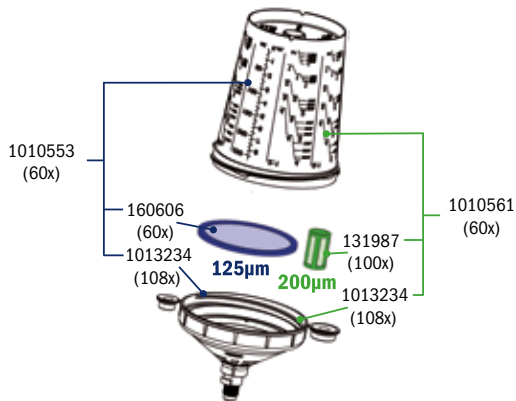

SATA RPS 0,6 l

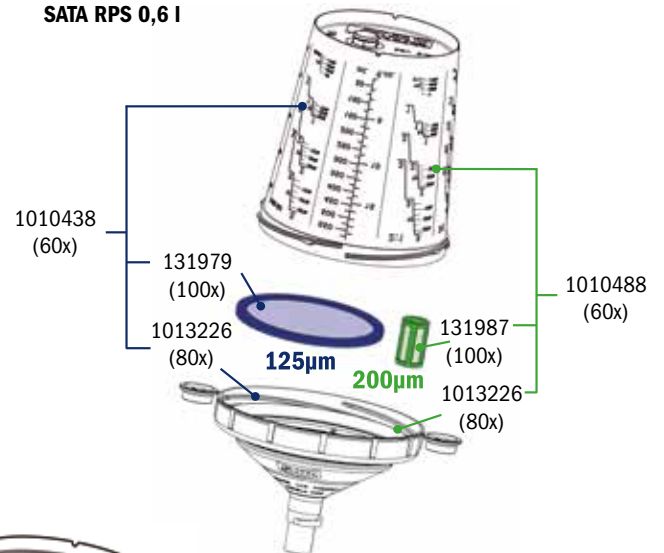

SATA RPS 0,9 l

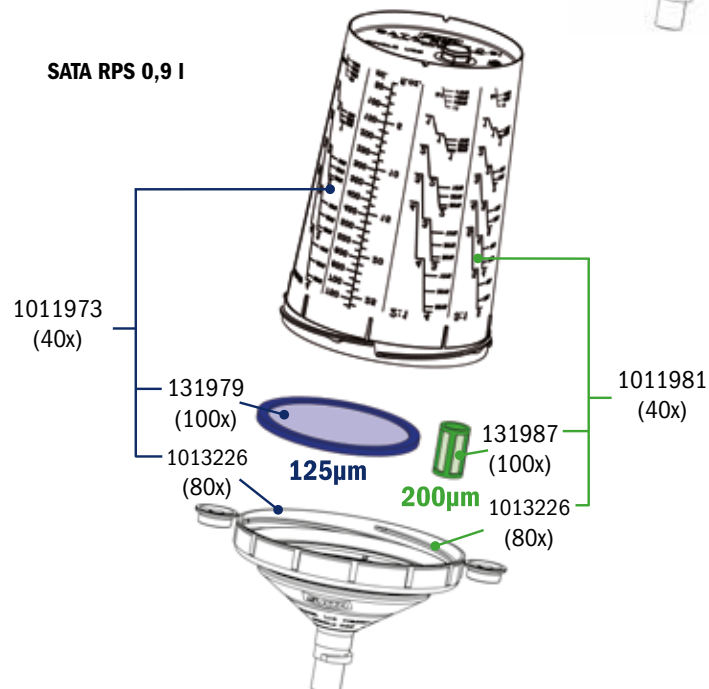



Todos los precios son precios de venta recomendados no obligatorios. Errores, modificaciones técnicas y erratas reservados.

Accesorios para SATA® RPS®



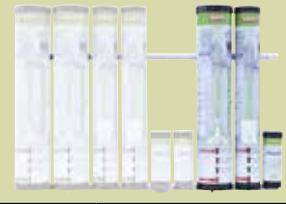

SATA RPS dispenser System

Datos técnicos		
	SATA RPS wall dispenser	Lar x alt x anch: 80 x 100 x 18 cm
	SATA RPS extension kit	Lar x alt x anch: 40 (120) x 100 x 18 cm
	SATA RPS rotawall adapter kit	Lar: Ø 65 cm; Alt: 136 cm
	SATA RPS rotafloor adapter kit	Lar: Ø 65 cm Alt. máx: 210 cm; Alt. min: 123 cm

Variantes













195784	SATA RPS wall dispenser, variante estándar: 2x tubo de depósito / 2x tubo de tapa / 2x tubo de tamiz y 2x listón de aluminio	
195776	SATA RPS extension kit, juego de ampliación: 1x tubo para depósito / 1x tubo para tapa / 1x tubo para tamices planos, sin listones de aluminio	
196543	SATA RPS rotawall adapter kit: carusel, huso de fondo y soporte para la pared (arriba y abajo)	 * Tubos no incluidos en el volumen de suministro.
196550 + 197723 (placa de base)	SATA RPS rotafloor adapter kit: carusel, husillo de fondo, tubo de acero	 * Tubos no incluidos en el volumen de suministro.

Accesorios para SATA RPS

144840	Soporte SATA RPS para el almacenamiento de cartones RPS	
127852	Botella pulverizadora 1,0 l	
127860	Botella de bombeo de limpieza, no apropiada para disolventes	
165399	SATA RPS mix lid, tapa plana (paquete de 50 unidades) posibilita el apilamiento de depósitos RPS 0,6 l y 0,9 l	

Todos los precios son precios de venta recomendados no obligatorios. Errores, modificaciones técnicas y erratas reservados.

Accesorios para SATA RPS

213629	Juego de fijación para tubo cinta adhesiva, película adhesiva, soporte para cinta adhesiva para SATA RPS dispenser	
213637	Soporte de depósito para tubo para SATA RPS dispenser	
213645	Cepillo para tapa estándar para SATA RPS dispenser	
213652	Cepillo para tapa mini para SATA RPS dispenser	
213660	Tubo de cartón para tapa para SATA RPS dispenser	
213678	Tubo de cartón para depósito para SATA RPS dispenser	
213686	Tubo para tamices de enchufe y planos para SATA RPS dispenser	
215483	Remaches de sujeción (paquete de 4 unidades) para cepillo para SATA RPS dispenser	
215616	Pieza de recambio suelo del dispensador de filtros planos (1x) para SATA RPS dispenser	
1008285	Soporte para dispensador de tapas para SATA RPS dispenser	
1008227	Tapa de dispensador para tamices de enchufe para SATA RPS dispenser	
1008219	Envase dispensador para tamices de enchufe para SATA RPS dispenser	
1028605	Pieza de recambio suelo delo dispensador de filtros de enchufe para SATA RPS dispenser	

Todos los precios son precios de venta recomendados no obligatorios. Errores, modificaciones técnicas y erratas reservados.

Depósitos de gravedad para pistolas de pintura

Tipo de pistola		QCC/SIN rosca fina adecuado para: SATAjet X 5500, SATAjet 5000 B, jet 4000 B, jet 3000 B, jet 2000, jet 1000 B, jet 100 B, , jet RP, SATAminijet 4400 B	QCC/CON rosca fina para: SATAjet 2000, jet RP, KLC, LM 2000 B, jet 90	SATAjet B, jet GR, jet NR 95	SATAminijet 3000 B, minijet 1 - 4, jet 20 B
Volumen	Ref.				
Depósito de plástico reutilizable					
0,125 l	197541				
0,125 l	125443				
0,3 l	48587				
0,3 l	120675				
0,3 l	128470				
0,6 l	49379				
0,6 l	27243		1004960 		
RPS depósitos multiuso					
0,3 l	1010553				cada 60 x 
0,3 l	1010561				cada 60 x 
0,3 l	1010389	cada 40 x 		 ⊕  125211	
0,3 l	1010397	cada 40 x 		 ⊕  125211	
0,3 l	1010420	cada 100 x 		 ⊕  125211	
0,3 l	1010404	cada 100 x 		 ⊕  125211	
0,6 l	1010438	cada 60 x 		 ⊕  125211	 ⊕  135798
0,6 l	1010488	cada 60 x 		 ⊕  125211	 ⊕  135798
0,9 l	1011973	cada 40 x 		 ⊕  125211	 ⊕  135798
0,9 l	1011981	cada 40 x 		 ⊕  125211	 ⊕  135798

Todos los precios son precios de venta recomendados no obligatorios. Errores, modificaciones técnicas y erratas reservados.

Adaptadores RPS® para pistolas de pintura SATA

Tipo de pistola		QCC/ sin rosca fina para: SATAjet X 5500, SATAjet 5000 B, jet 4000 B, jet 3000 B, jet 2000, jet 1000 B, jet 100 B, jet RP, SATAminijet 4400 B	QCC/CON rosca fina para: SATAjet 2000, jet RP, KLC, LM 2000 B, jet 90	SATAjet B, jet GR, jet NR 95	QCC CON rosca fina para: SATAminijet 3000 B, minijet 1 - 4, jet 20 B	
Volumen	Ref.					
Depósito de aluminio reutilizable						
0,15 l	198911					
0,15 l	125948					
0,75 l	6601					
0,75 l	137729		1013432			
1,0 l	46631					
1,0 l	96685		1013440			
	71555	Tapa de plástico (paquete de 3 unidades) para depósito de aluminio reutilizable de 0,75 l y 1,0 l				

















Adaptadores RPS® para pistolas de pintura SATA

Adaptador con QCC para pistolas de pintura SATA sin QCC para el cambio rápido de SATA RPS 0,9 l y 0,6 l y 0,3 l "estándar"		SATA										
		SATAjet B / GR	SATAjet H / SATAjet 1000 H	SATAminijet 2, 3, 4, SATAminijet 3000, SATAJet 20 B	SATAminijet 1000 H	SATAjet 2000 HVLP sin QCC	SATAjet RP sin QCC	SATA LM 2000 HVLP/RP	SATA KLC HVLP/RP, KLC P	SATAjet 90	SATAjet B NR 92 HVLP, NR 95 HVLP	SATA LM B 92
	125211 (Nr. 1) M 16 x 1.5 Rosca interior	X									X	
	125237 (Nr. 2) M 16 x 1.5 Rosca exterior					X	X	X	X	X		
	133595 (Nr. 7) 12 x 1.5 Rosca exterior											X
	135798 (Nr. 10) M 10 x 1 Rosca exterior			X								
	188318 (Nr. 17) G 1/4 Rosca interior				X							

(N° ...) Números de los adaptadores

Todos los precios son precios de venta recomendados no obligatorios. Errores, modificaciones técnicas y erratas reservados.

Adaptadores RPS® para pistolas ajenas

Adaptador con QCC para pistolas ajenas para el cambio rápido de SATA RPS 0,9 l y 0,6 l y 0,3 l "estándar"	DeVilbiss				IWATA				Walcom		Kremlin	Graco	Dürr	Sharpe	Sagola			Eminent	Asturo	Airgunsa	Dux	
	PH, GTI, GPP, GRV, GRHV 510, DV 1	SRI	Starting Line HVP Spray Gun	Starting Line Mini Spray Gun	W 400, WR 400, LPA 94, VXL Primer Gun, LPH 400	W 300, LPH 300, LS 400 Supernova, WS 400	W 100, LPH 100	LPH 80	FX GEO, FX HVP	Genesis Carbon	M 21 G	3M PPS	Ecogun 910	Finex FX 300	Platinum, Titanium	475 Mini-Gun	403 G, 433 G, 434 G, 444 G, 450 G, 4100 G	4400 G Extreme, 4500 G Extreme	E13	OM Green	AZ40 HTE	Pistola con depósito de gravedad
 125211 (Nr. 1) M 16 x 1.5 Rosca interior					X																	
 125237 (Nr. 2) M 16 x 1.5 Rosca exterior									X													
 125252 (Nr. 3) 3/8" Rosca exterior	X																					
 125278 (Nr. 4) 1/4 " Rosca exterior					X													X		X		
 125294 (Nr. 5) M 12 x 1 Rosca exterior								X												X		
 126326 (Nr. 6) 3/8" Rosca exterior											X											
 133595 (Nr. 7) 12 x 1.5 Rosca exterior																X						X
 133827 (Nr. 8) G 3/8" Rosca interior													X	X								
 135111 (Nr. 9) NPSF 3/8" - 18 Rosca exterior														X								
 135798 (Nr. 10) M 10 x 1 Rosca exterior															X							
 150136 (Nr. 13) M 16 x 1.5 Rosca exterior			X																			
 150151 (Nr. 14) M 11 x 1 Rosca exterior				X																		
 164608 (Nr. 15) 7/16" - 14 UNC Rosca exterior		X																				
 188664 (Nr. 18) M 18 x 1.5 Rosca interior																	X					
 193276 (Nr. 19) 1/8" Rosca exterior							X															
 215079 (Nr. 20) 1/4 " Rosca exterior										X												

(N° ...) Números de los adaptadores

Todos los precios son precios de venta recomendados no obligatorios. Errores, modificaciones técnicas y erratas reservados.

Depósito agitador SATA®

Depósito agitador SATA		
9951	Depósito agitador SATA, juego de ampliación para SATAjet B/ GR	
29926	Depósito agitador SATA, juego de ampliación para SATAjet 5000 B, 4000 B, jet 3000 B, jet 2000, jet RP, jet 1000 B, LM 2000 B	

Ref./Descrip.	
1503	Tornillo avellanado, acero fino
1826	Antigoteo (paquete de 4 unidades)
2188	Huso
9951	Depósito agitador SATA, juego de ampliación
20461	Manguera de aire, plástico
21055	Paleta agitadora, cpl.
21063	Ala de accionamiento, cpl. con tornillo
21071	Junta ala agitadora, agitador de depósito
29926	Depósito agitador SATA, juego de ampliación
44735	Tornillo avellanado M 2,5 x 5, VA
44743	Botón moleteado
44792	Huso para regulación de abanico redondo / ancho
51078	Cuerpo de válvula reguladora completo con agitador de depósito
53785	Atomilladura de casquillo de inserción acodado, giratoria,
53793	Acoplamiento con G 1/8" (roscas interior)
54049	Anillo de junta (paquete de 4 unidades)
65557	Botón moleteado
123513	Manómetro 0-10 bar, 40 mm para válvula reguladora cliché colorido

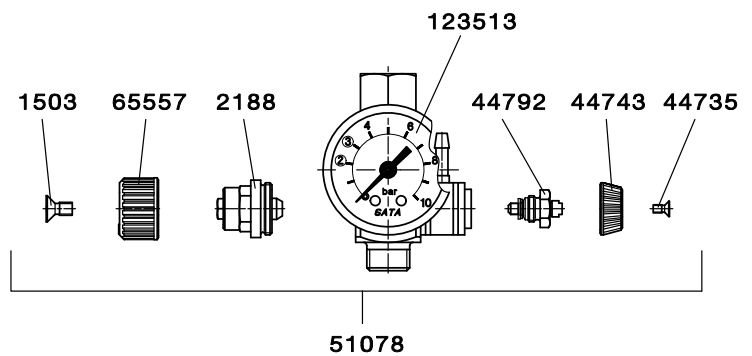
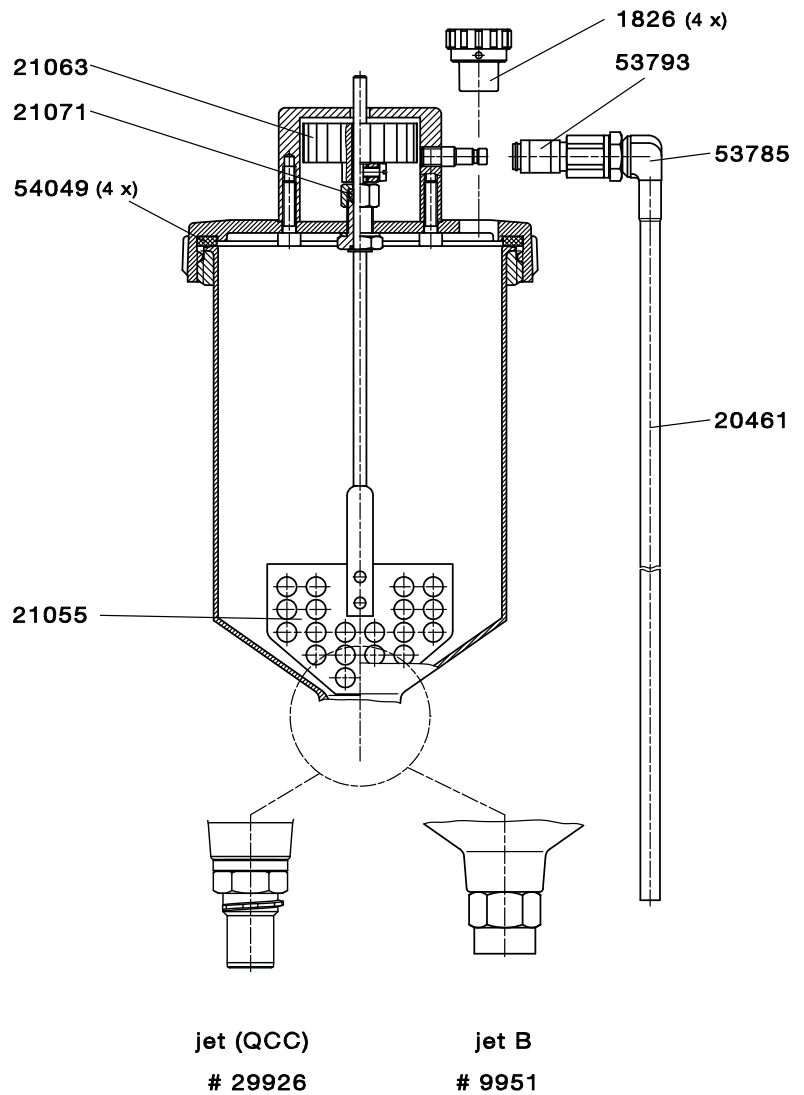

Todos los precios son precios de venta recomendados no obligatorios. Errores, modificaciones técnicas y erratas reservados.

SATA® BVD™

Juego SATA BVD		
25775	Juego de ampliación SATA BVD para SATAjet 5000 B, 4000 B, jet 3000 B, jet 2000, jet RP, jet 1000 B, LM 2000 B	
57505	Juego de ampliación SATA BVD para SATAjet B	
73254	Juego de reparación, para guarnición regulable spray master y BVD	

Ref./Descrip.
8268
Anillo de junta
20438
Válvula de seguridad PN 2
20461
Manguera de aire, plástico
21014
Tapa de aluminio, cpl.
21048
Depósito de presión con tapa
25577
Depósito de presión con tapa
53777*
Conexión de aire para tapa de aluminio
54049
Anillo de junta (paquete de 4 unidades)
65920
Guarnición regulable, cpl.
70664
Antigoteo (paquete de 10 unidades)
83493
Conexión para depósito de presión, cpl.
83501
Manguera de aire, cpl. con conexión para depósito de presión
120816
Tornillo de purga de presión (paquete de 2 unidades)
133983
Pieza de toma de aire 1/4" (rosca exterior)
* por favor pedir también 8268

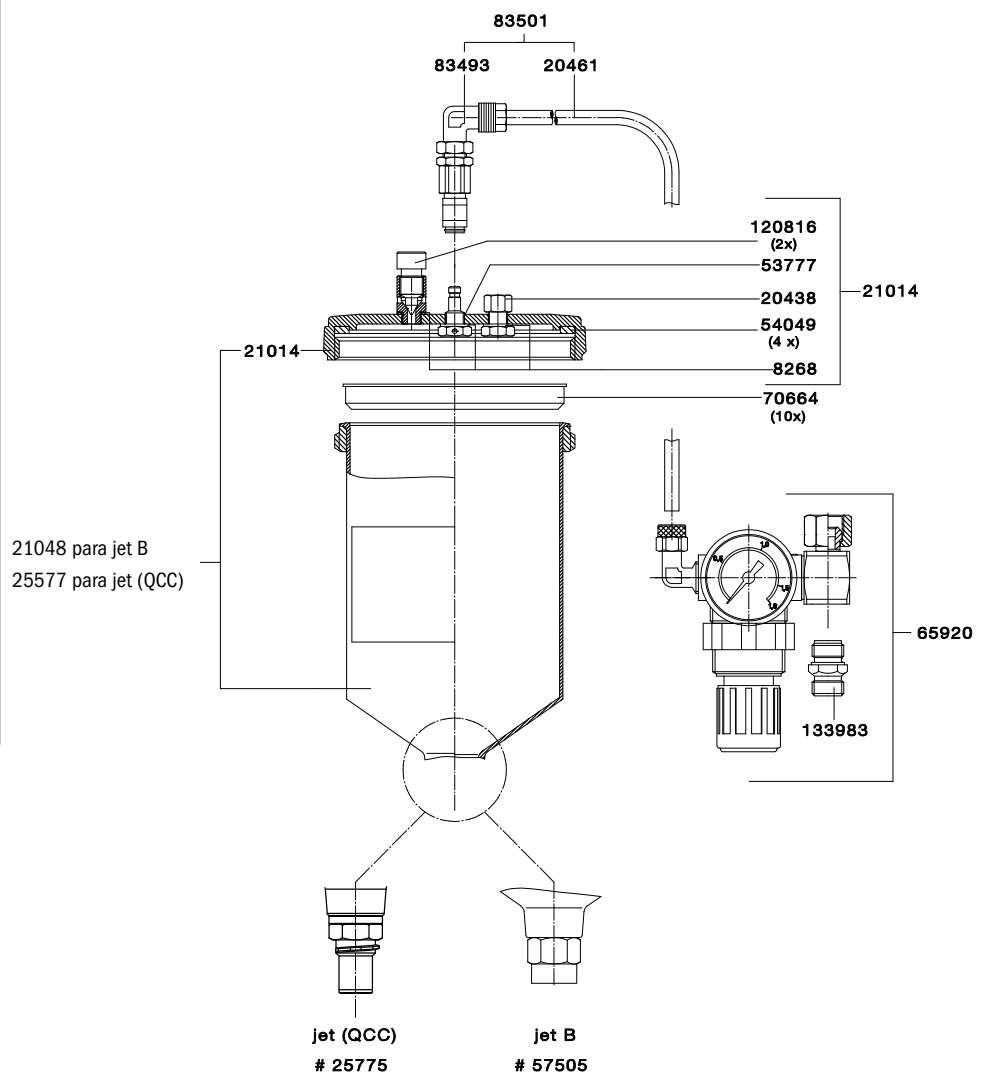

Todos los precios son precios de venta recomendados no obligatorios. Errores, modificaciones técnicas y erratas reservados.